

Flat Base

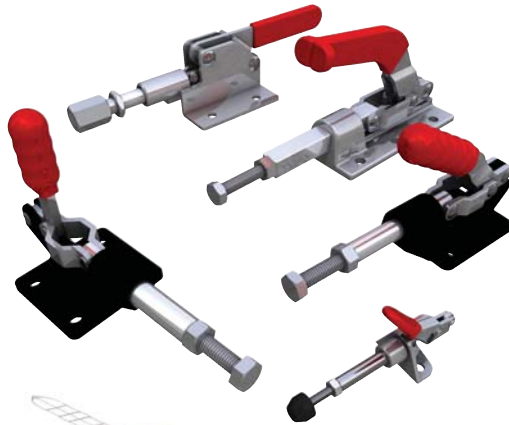

Low Profile Flat Base

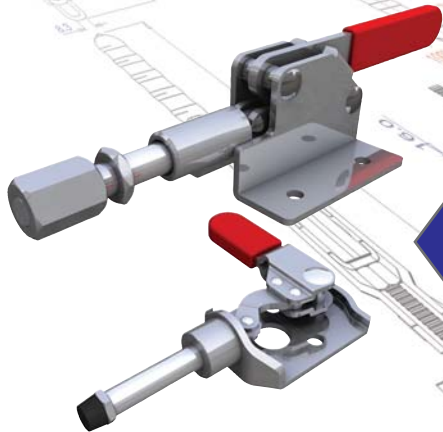

Nose Mounted

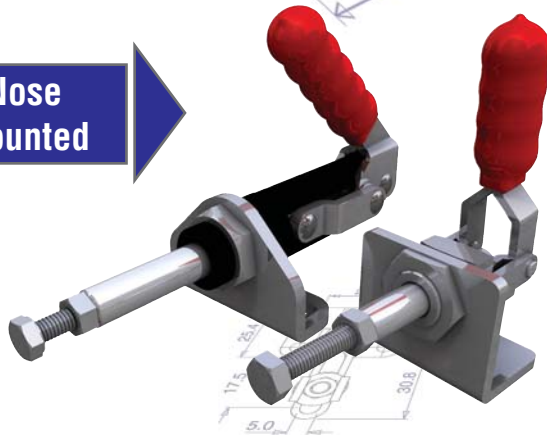

Heavy Duty Long & Short Handles

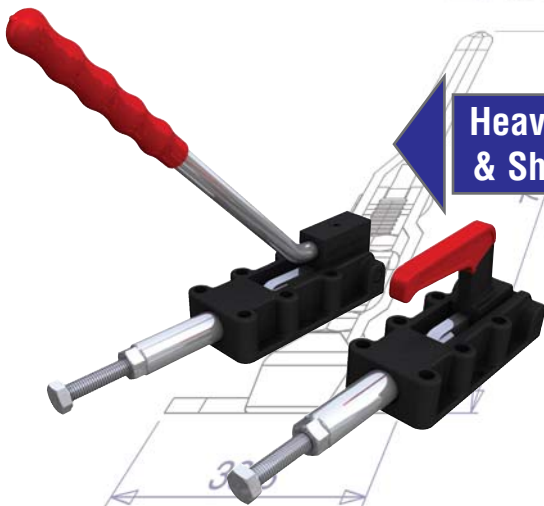

Precision Heavy Duty with Square Plunger

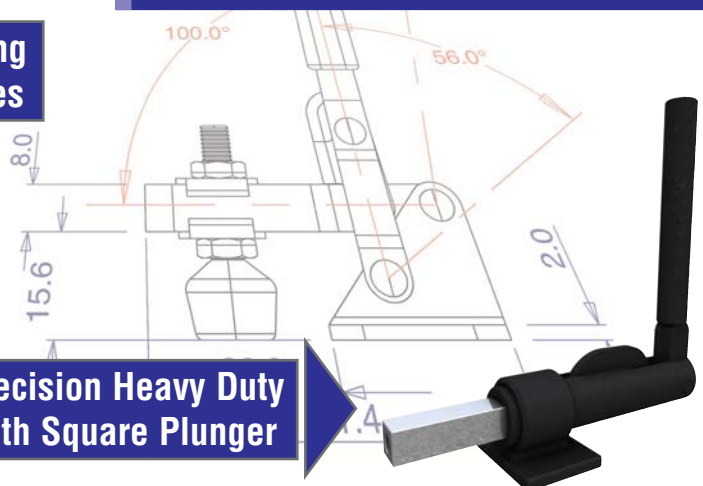

Push-Pull toggle clamps use a plunger mechanism to produce a positive straight-line action. They have the advantage of having a low profile, using side or end clamping and so are most suitable for applications having a height restriction.

Features include:

- Red vinyl hand grip with cushioned rib profile for improved user comfort.
- All body and linkage components on the light duty range are zinc plated to resist corrosion.
- The heavy-duty range has ductile cast iron bases for strength and rigidity.
- A close tolerance is maintained between the base and plunger to allow use for pin location and gauging as well as clamping applications.
- Pivot points are fitted with hardened steel or stainless steel rivets to maintain accuracy and provide a long service life.

► Flat Base

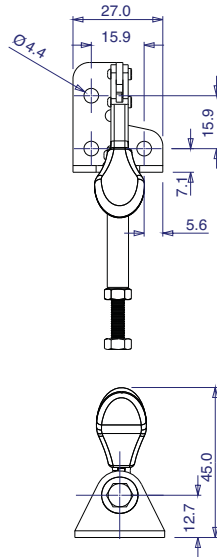

Part No:	GH-301-AM
Holding Force:	45Kg
Plunger Stroke:	16mm
Handle Opens:	190°
Weight:	0.05Kg
Spindle Supplied:	SA-042007
Flanged Washers Supplied:	-

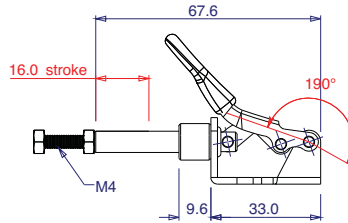

stainless

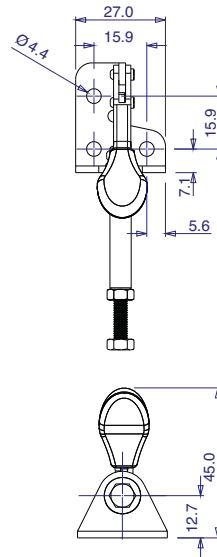

Part No:	GH-301-AMSS
Holding Force:	45Kg
Plunger Stroke:	16mm
Handle Opens:	190°
Weight:	0.05Kg
Spindle Supplied:	SA-042007-SS
Flanged Washers Supplied:	-

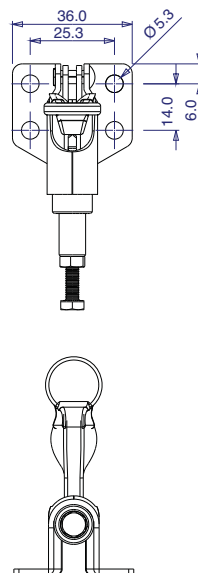
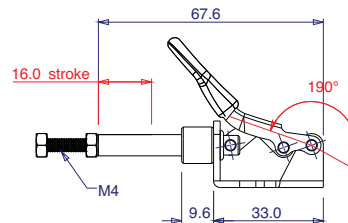

Part No:	GH-36006
Holding Force:	50Kg
Plunger Stroke:	11mm
Handle Opens:	93°
Weight:	0.07Kg
Spindle Supplied:	SA-041507
Flanged Washers Supplied:	-

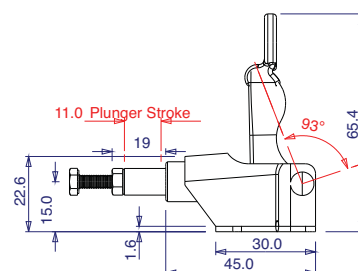

► Flat Base

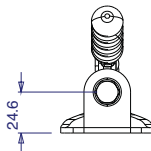
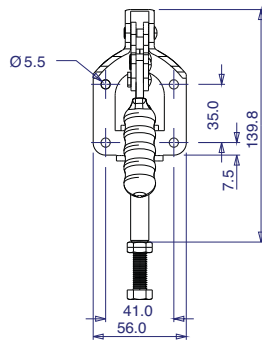

Part No:	GH-302-FM
Holding Force:	136Kg
Plunger Stroke:	32mm
Handle Opens:	180°
Weight:	0.30Kg
Spindle Supplied:	SA-085012
Flanged Washers Supplied:	-

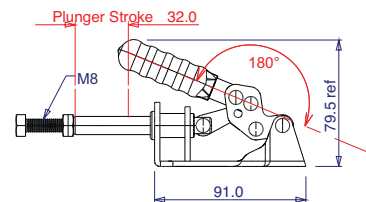

stainless

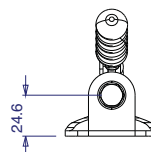
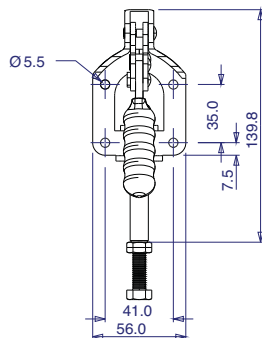

Part No:	GH-302-FMSS
Holding Force:	136Kg
Plunger Stroke:	32mm
Handle Opens:	180°
Weight:	0.30Kg
Spindle Supplied:	SA-085012-SS
Flanged Washers Supplied:	-

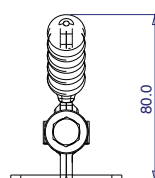
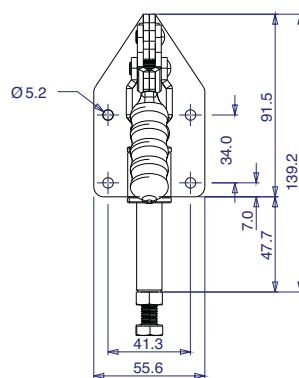
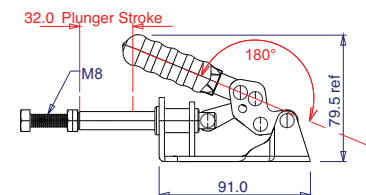

Part No:	GH-36092M
Holding Force:	180Kg
Plunger Stroke:	31.8mm
Handle Opens:	180°
Weight:	0.397Kg
Spindle Supplied:	SA-08501
Flanged Washers Supplied:	-

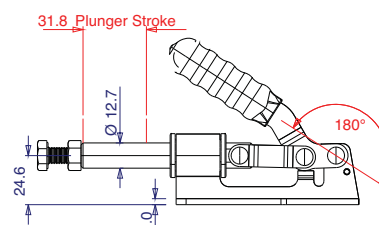

► Flat Base

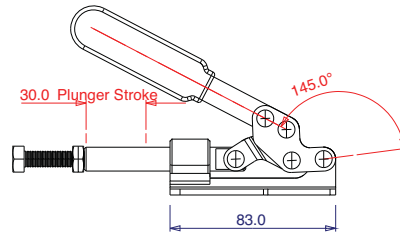
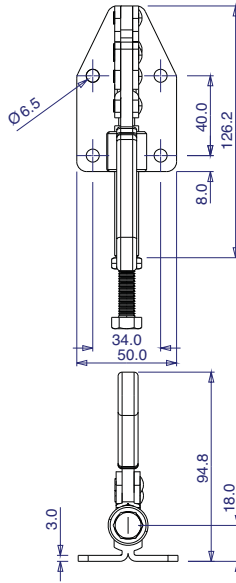

Part No:	GH-36020M
Holding Force:	180Kg
Plunger Stroke:	30mm
Handle Opens:	145°
Weight:	0.35Kg
Spindle Supplied:	SA-085012
Flanged Washers Supplied:	-

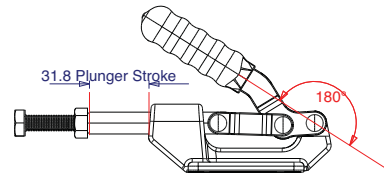
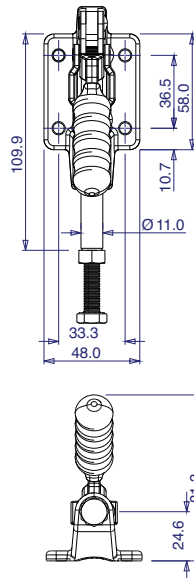

Part No:	GH-36003M
Holding Force:	272Kg
Plunger Stroke:	31.8mm
Handle Opens:	180°
Weight:	0.36Kg
Spindle Supplied:	SA-085012
Flanged Washers Supplied:	-

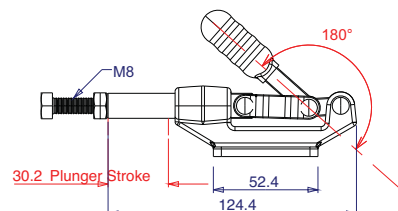
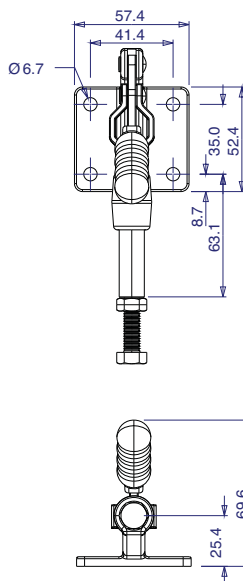

Part No:	GH-304-CM
Holding Force:	227Kg
Plunger Stroke:	30.2mm
Handle Opens:	180°
Weight:	0.34Kg
Spindle Supplied:	SA-085012
Flanged Washers Supplied:	-



► Flat Base

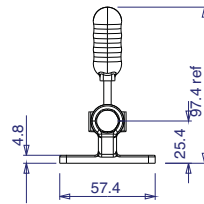
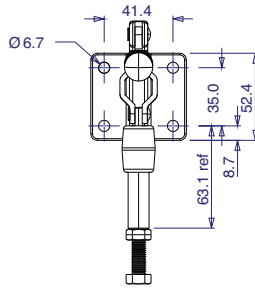

Part No:	GH-305-CM
Holding Force:	227Kg
Plunger Stroke:	30.2mm
Handle Opens:	90°
Weight:	0.34Kg
Spindle Supplied:	SA-085012
Flanged Washers Supplied:	-

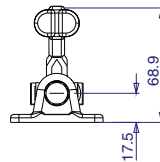
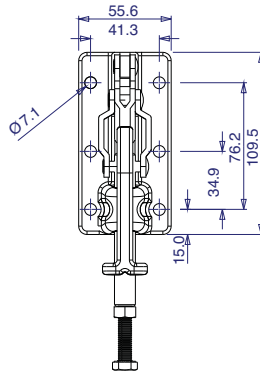
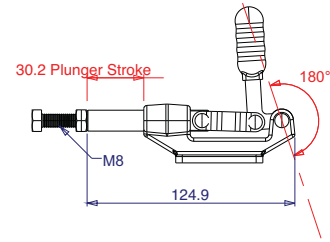

Part No:	GH-30607M
Holding Force:	318Kg
Plunger Stroke:	41.3mm
Handle Opens:	180°
Weight:	0.70Kg
Spindle Supplied:	SA-085012
Flanged Washers Supplied:	-

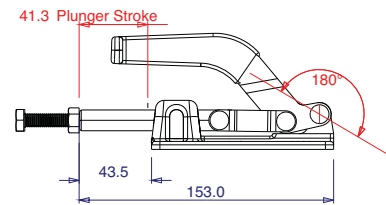

Square plunger

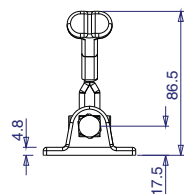
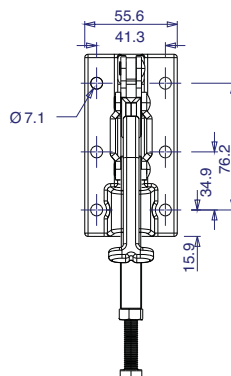

Part No:	GH-30608M
Holding Force:	318Kg
Plunger Stroke:	41.3mm
Handle Opens:	180°
Weight:	0.7Kg
Spindle Supplied:	SA-085012
Flanged Washers Supplied:	-

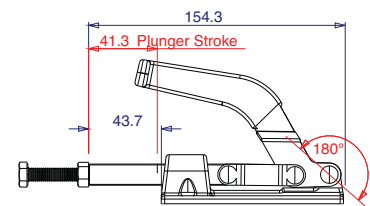

► Flat Base

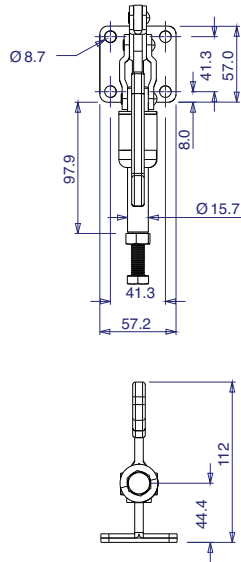

Part No:	GH-36010M
Holding Force:	364Kg
Plunger Stroke:	41.3mm
Handle Opens:	180°
Weight:	0.80Kg
Spindle Supplied:	SA-105015
Flanged Washers Supplied:	-

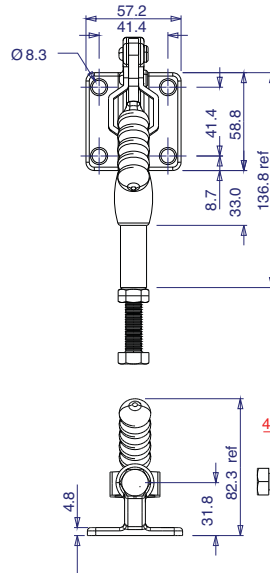
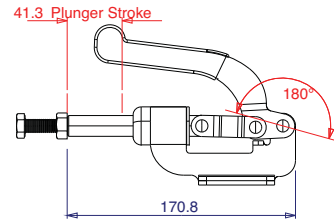

Part No:	GH-304-EM
Holding Force:	386Kg
Plunger Stroke:	41.4mm
Handle Opens:	180°
Weight:	0.58Kg
Spindle Supplied:	SA-105015
Flanged Washers Supplied:	-

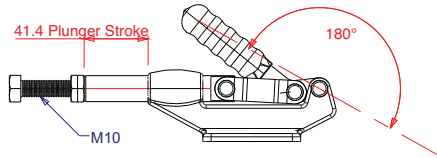

stainless

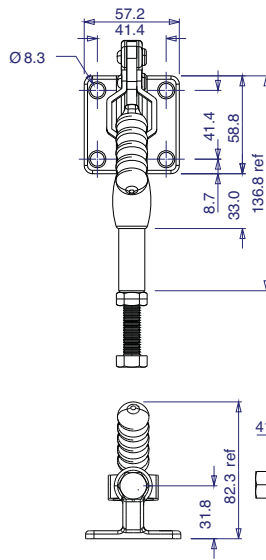

Part No:	GH-304-EMSS
Holding Force:	386Kg
Plunger Stroke:	41.4mm
Handle Opens:	180°
Weight:	0.58Kg
Spindle Supplied:	SA-105015-SS
Flanged Washers Supplied:	-

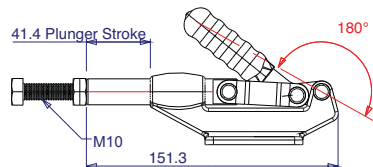

► Flat Base

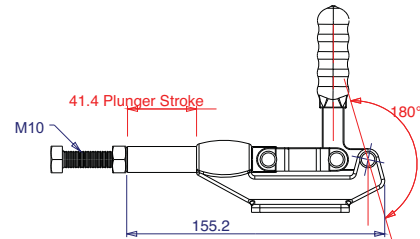
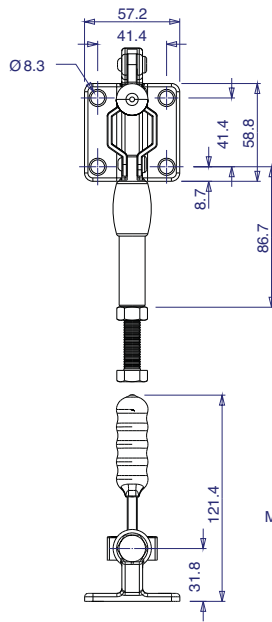

Part No:	GH-305-EM
Holding Force:	386Kg
Plunger Stroke:	41.4mm
Handle Opens:	90°
Weight:	0.58Kg
Spindle Supplied:	SA-105015
Flanged Washers Supplied:	-

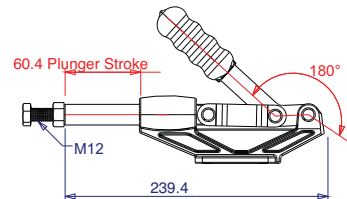
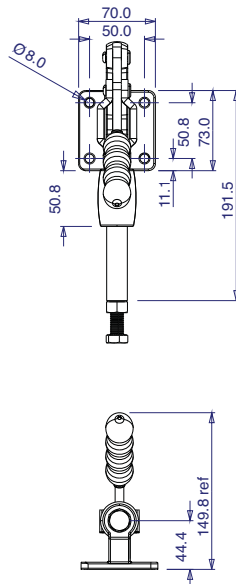

Part No:	GH-304-HM
Holding Force:	680Kg
Plunger Stroke:	60.4mm
Handle Opens:	180°
Weight:	1.48Kg
Spindle Supplied:	SA-125017
Flanged Washers Supplied:	-

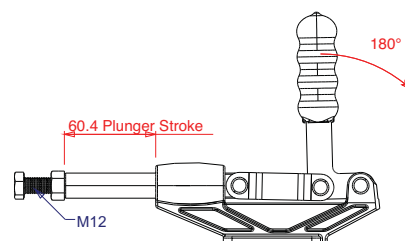
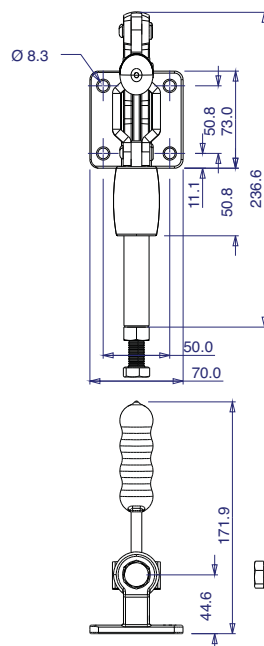

Part No:	GH-305-HM
Holding Force:	680Kg
Plunger Stroke:	60.4mm
Handle Opens:	90°
Weight:	1.48Kg
Spindle Supplied:	SA-125017
Flanged Washers Supplied:	-



► Flat Base

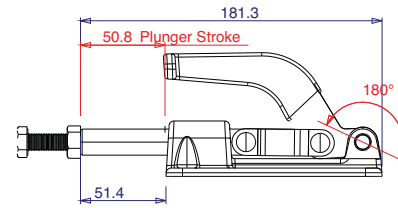
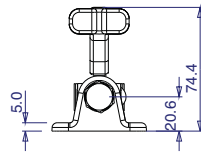
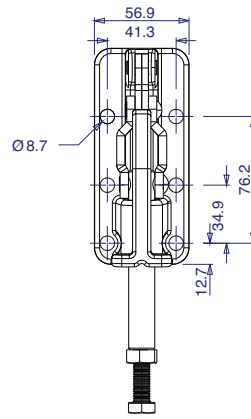

Part No:	GH-36330M
Holding Force:	1136Kg
Plunger Stroke:	50.8mm
Handle Opens:	180°
Weight:	0.94Kg
Spindle Supplied:	SA-105015
Flanged Washers Supplied:	-

► Low Profile Flat Base

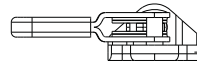
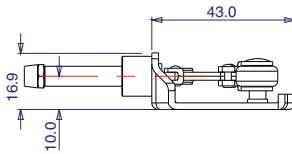
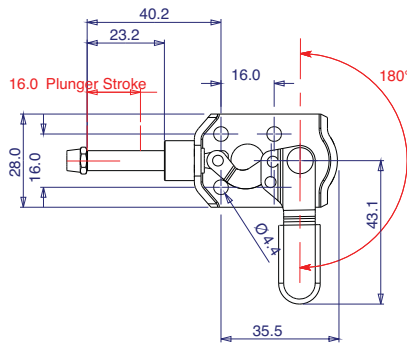

Part No:	GH-301-CML
Holding Force:	45Kg
Plunger Stroke:	16mm
Handle Opens:	190°
Weight:	0.05Kg
Spindle Supplied:	FC-041807
Flanged Washers Supplied:	-

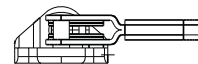
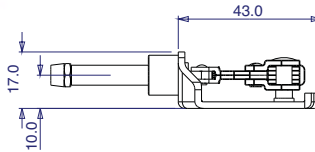
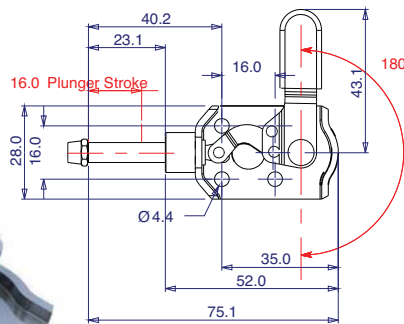
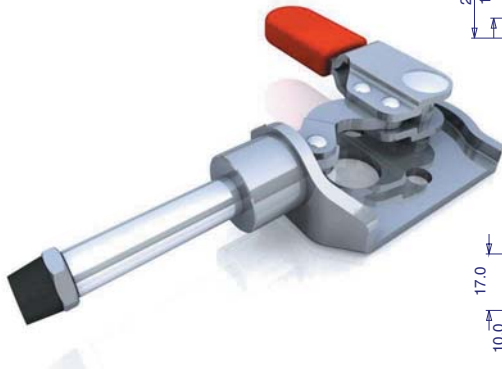

Part No:	GH-301-CMR
Holding Force:	45Kg
Plunger Stroke:	16mm
Handle Opens:	190°
Weight:	0.05Kg
Spindle Supplied:	FC-041807
Flanged Washers Supplied:	-

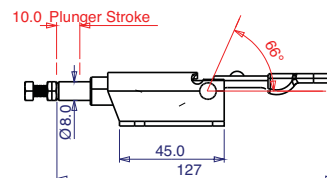
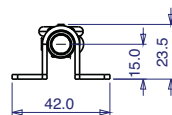
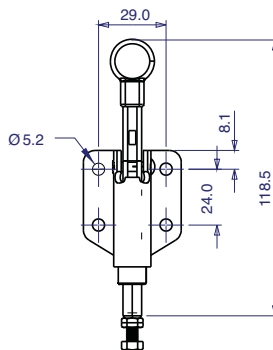

Part No:	GH-36070M
Holding Force:	50Kg
Plunger Stroke:	10mm
Handle Opens:	66°
Weight:	0.1Kg
Spindle Supplied:	SA-051508
Flanged Washers Supplied:	-

► Low Profile Flat Base

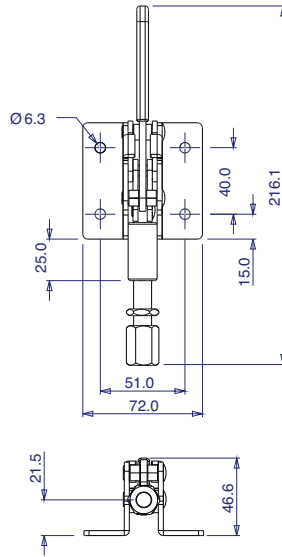

Part No:	GH-302-DM
Holding Force:	160Kg
Plunger Stroke:	12mm
Handle Opens:	45°
Weight:	0.45Kg
Spindle Supplied:	-
Flanged Washers Supplied:	-

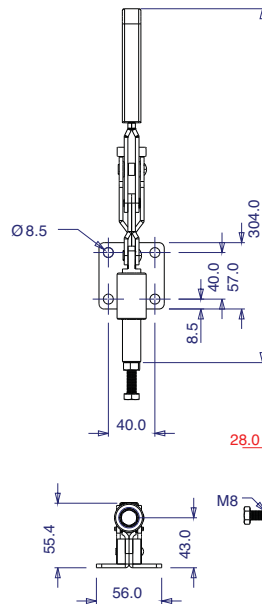
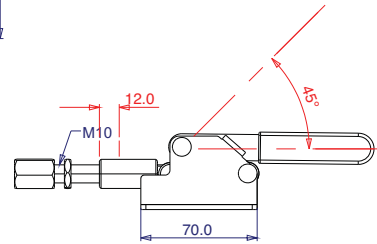

Part No:	GH-36060M
Holding Force:	300Kg
Plunger Stroke:	28mm
Handle Opens:	76°
Weight:	0.615Kg
Spindle Supplied:	SA-083012
Flanged Washers Supplied:	-

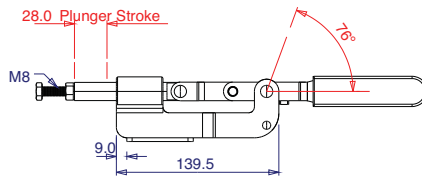

► Nose Mounted

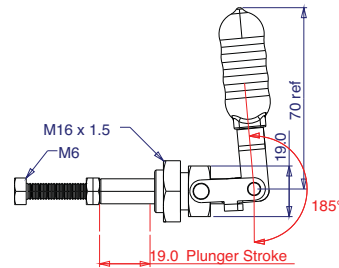
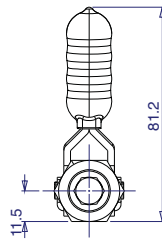
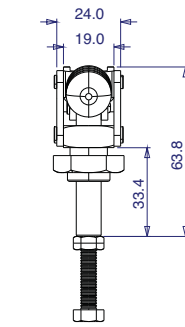

Part No:	GH-36202M
Holding Force:	91Kg
Plunger Stroke:	19mm
Weight:	0.113Kg
Spindle Supplied:	SA-064010
Optional Bracket:	GH-36203
Locknut Supplied:	M16 x 1.5

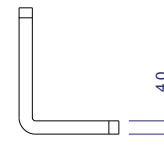
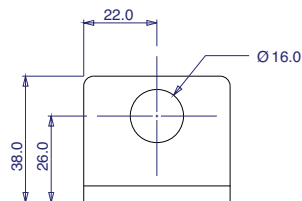
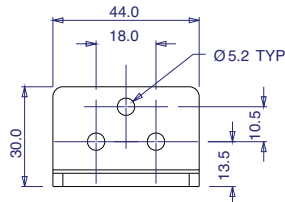

Part No:	GH-36203
Bracket to suit:	GH-36202M
Finish:	Zinc plated

stainless

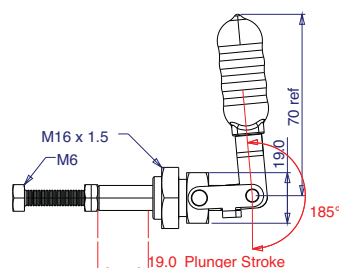
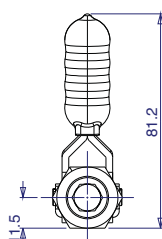
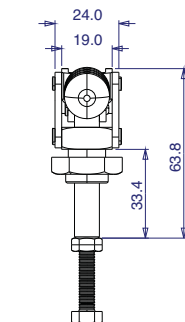

Part No:	GH-36202-MSS
Holding Force:	91Kg
Plunger Stroke:	19mm
Weight:	0.113Kg
Spindle Supplied:	SA-064010-SS
Optional Bracket:	-
Locknut Supplied:	M16 x 1.5



► Nose Mounted

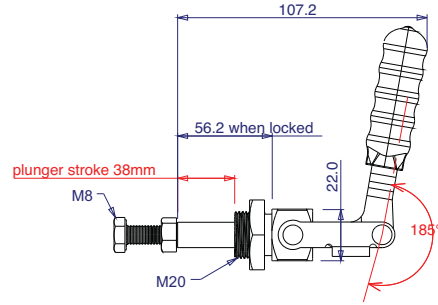
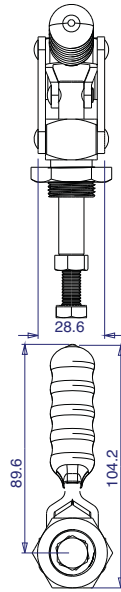
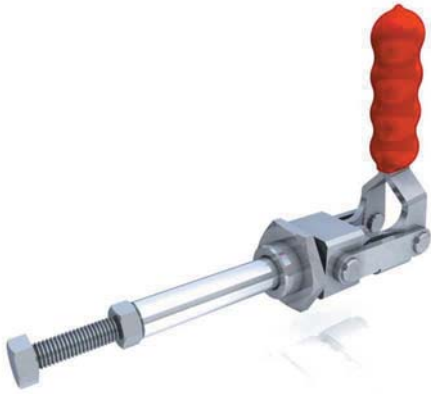

Part No:	GH-36204M
Holding Force:	136Kg
Plunger Stroke:	38mm
Weight:	0.27Kg
Spindle Supplied:	SA-085012
Optional Bracket:	GH-36205
Locknut Supplied:	M20 x 1.5

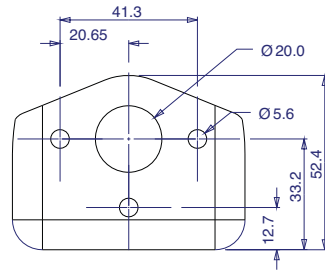
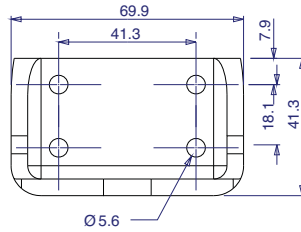

Part No:	GH-36205
Bracket to suit:	GH-36204M
Finish:	Zinc plated

stainless

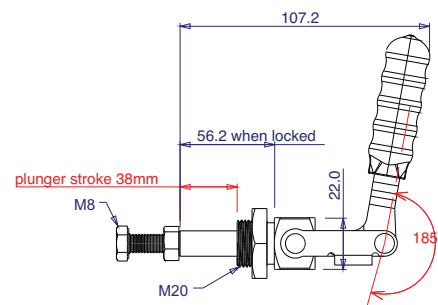
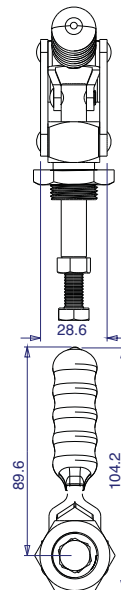

Part No:	GH-36204-MSS
Holding Force:	136Kg
Plunger Stroke:	38mm
Weight:	0.27Kg
Spindle Supplied:	SA-085012-SS
Optional Bracket:	-
Locknut Supplied:	M20 x 1.5



▶ Nose Mounted

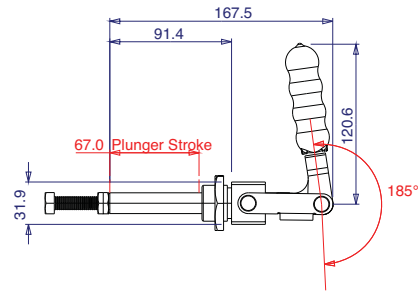
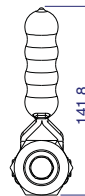
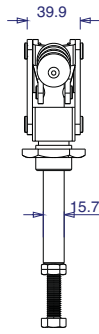
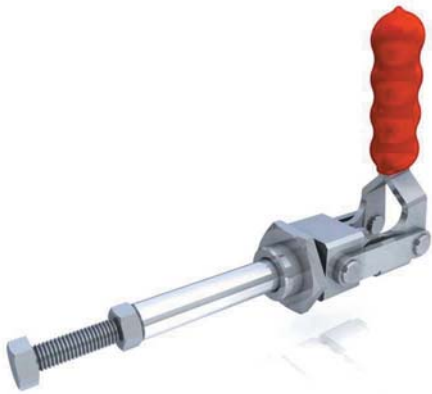

Part No:	GH-36224M
Holding Force:	318Kg
Plunger Stroke:	66.8mm
Weight:	0.69Kg
Spindle Supplied:	SA-105015
Optional Bracket:	GH-36225
Locknut Supplied:	M27 x 1.5

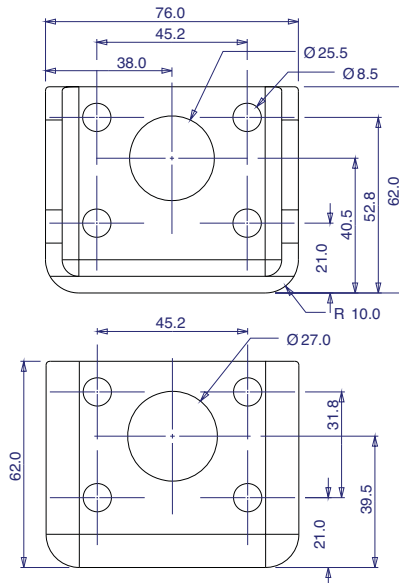

Part No:	GH-36225
Bracket to suit:	GH-36224M
Finish:	Zinc plated

stainless

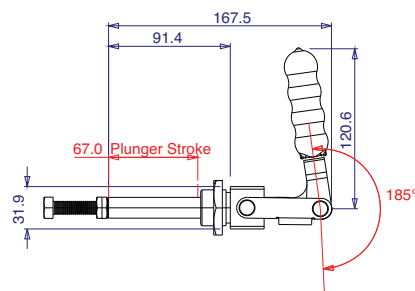
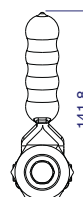
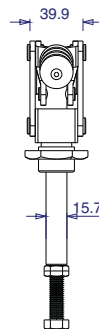

Part No:	GH-36224-MSS
Holding Force:	318Kg
Plunger Stroke:	66.8mm
Weight:	0.69Kg
Spindle Supplied:	SA-105015-SS
Optional Bracket:	-
Locknut Supplied:	M27 x 1.5



► Nose Mounted

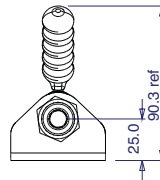
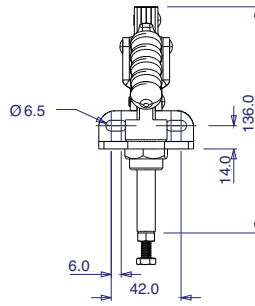

Part No:	GH-30250M
Holding Force:	250Kg
Plunger Stroke:	32mm
Handle Opens:	190°
Weight:	0.385Kg
Spindle Supplied:	SA-062010
Threaded Collar	M20 x 1.5

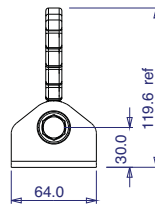
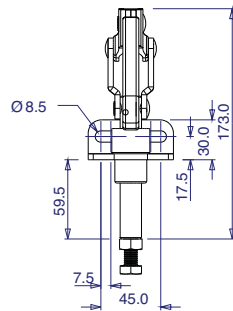
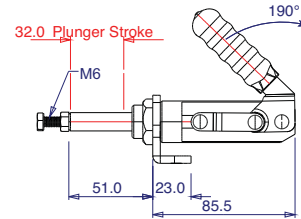

Part No:	GH-30450M
Holding Force:	450Kg
Plunger Stroke:	38mm
Handle Opens:	185°
Weight:	0.774Kg
Spindle Supplied:	SA-103015
Threaded Collar	M24 x 1.5

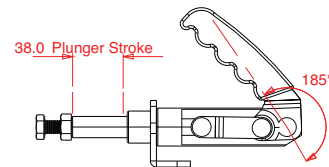

► Heavy Duty Long & Short Handles

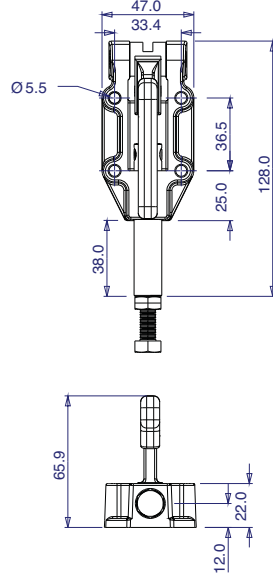

Part No:	GH-30600M
Holding Force:	600Kg
Plunger Stroke:	32mm
Handle Opens:	185°
Weight:	0.48Kg
Spindle Supplied:	SA-086512
Flanged Washers Supplied:	-

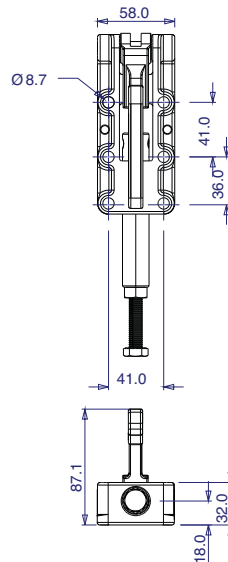
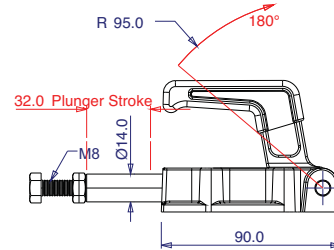

Part No:	GH-31200M
Holding Force:	1200Kg
Plunger Stroke:	51mm
Handle Opens:	185°
Weight:	1.5Kg
Spindle Supplied:	SA-107515
Flanged Washers Supplied:	-

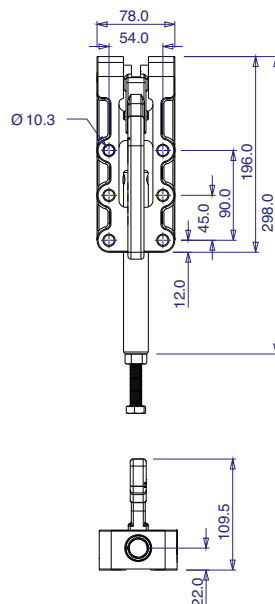
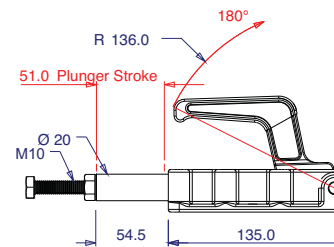

Part No:	GH-32500M
Holding Force:	2500Kg
Plunger Stroke:	75mm
Handle Opens:	180°
Weight:	3.7Kg
Spindle Supplied:	SA-125017
Flanged Washers Supplied:	-

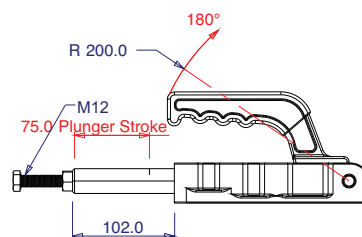

► Heavy Duty Long & Short Handles

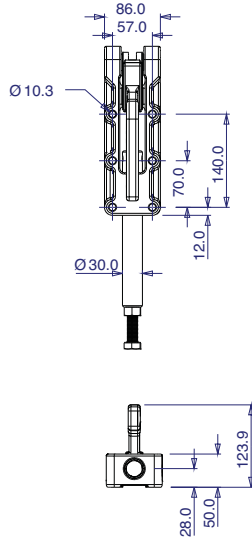
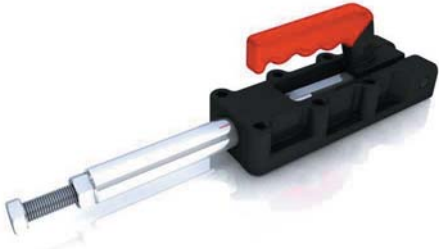

Part No:	GH-35000M
Holding Force:	5000Kg
Plunger Stroke:	100mm
Handle Opens:	185°
Weight:	6.5Kg
Spindle Supplied:	SA-167520
Flanged Washers Supplied:	-

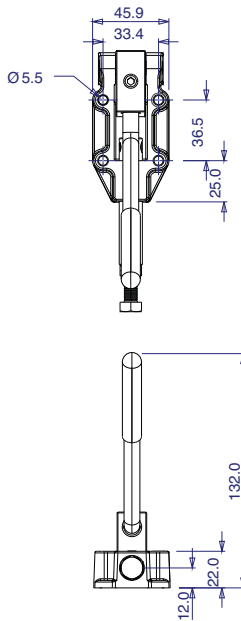
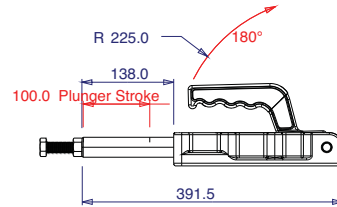

Part No:	GH-30600-HLM
Holding Force:	600Kg
Plunger Stroke:	32mm
Handle Opens:	180°
Weight:	0.48Kg
Spindle Supplied:	SA-086512
Flanged Washers Supplied:	-

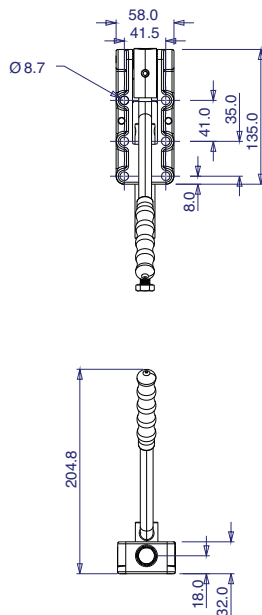
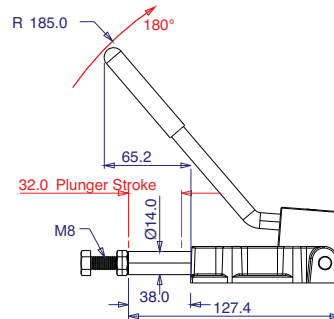

Part No:	GH-31200-HLM
Holding Force:	1200Kg
Plunger Stroke:	51mm
Handle Opens:	180°
Weight:	1.6Kg
Spindle Supplied:	SA-107515
Flanged Washers Supplied:	-

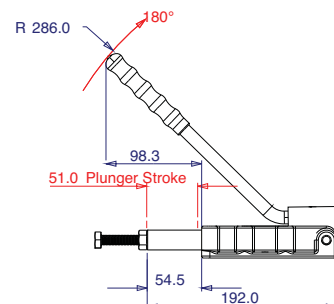

► Heavy Duty Long & Short Handles

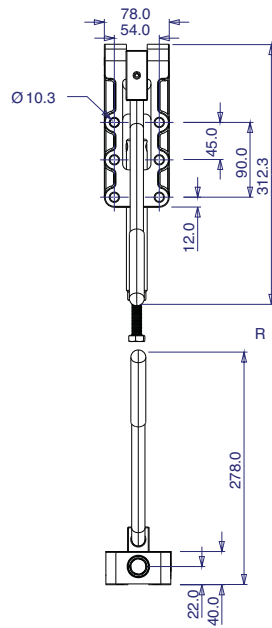

Part No:	GH-32500-HLM
Holding Force:	2500Kg
Plunger Stroke:	75mm
Handle Opens:	185°
Weight:	4.2Kg
Spindle Supplied:	SA-125017
Flanged Washers Supplied:	-

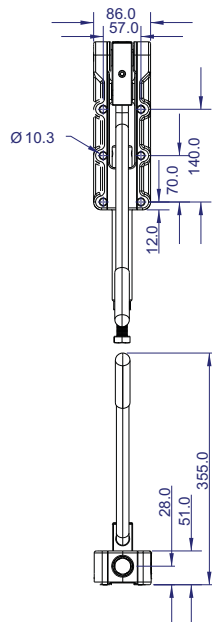
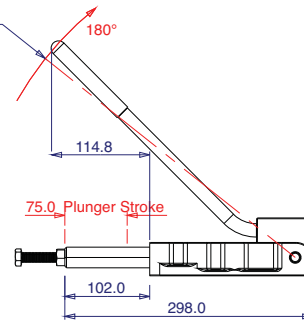

Part No:	GH-35000-HLM
Holding Force:	5000Kg
Plunger Stroke:	100mm
Handle Opens:	185°
Weight:	7.1Kg
Spindle Supplied:	SA-167520
Flanged Washers Supplied:	-

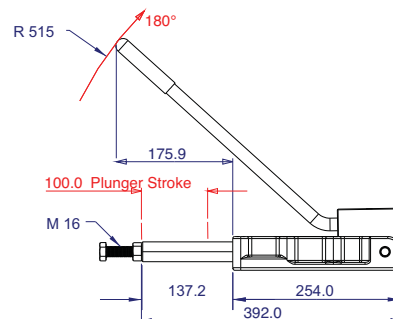

► Precision Heavy Duty with Square Plunger

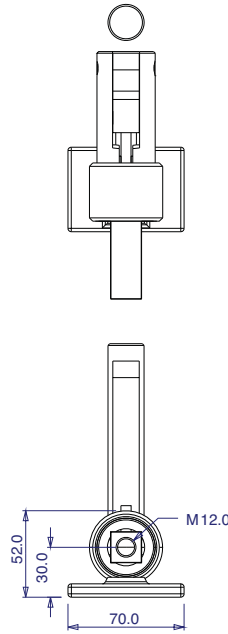

Part No:	GH-30509M
Holding Force:	1136Kg
Plunger Stroke:	43.8mm
Weight:	1.33Kg
Spindle Supplied:	SA-125017

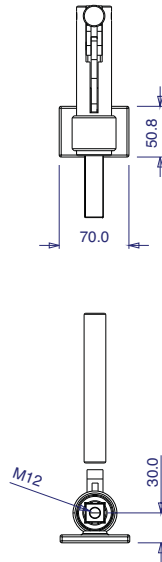
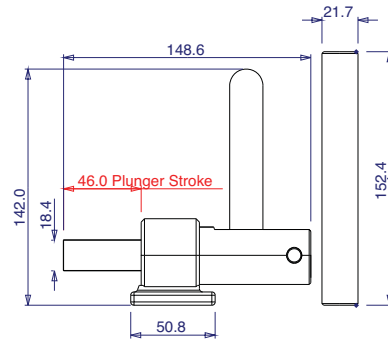

Part No:	GH-30519M
Holding Force:	1136Kg
Plunger Stroke:	59.5mm
Weight:	1.64Kg
Spindle Supplied:	SA-125017

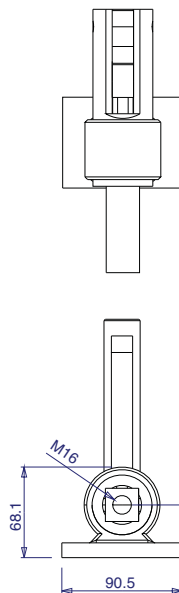
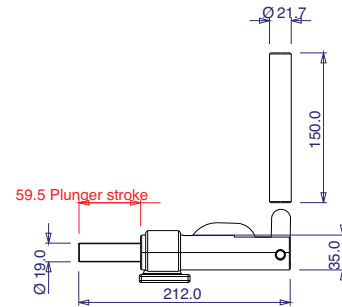

Part No:	GH-30609M
Holding Force:	2273Kg
Plunger Stroke:	59.5mm
Weight:	2.82Kg
Spindle Supplied:	SA-165020

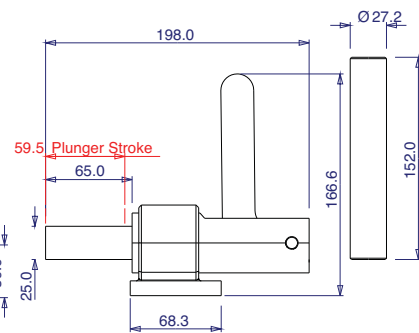

► Precision Heavy Duty
with Square Plunger

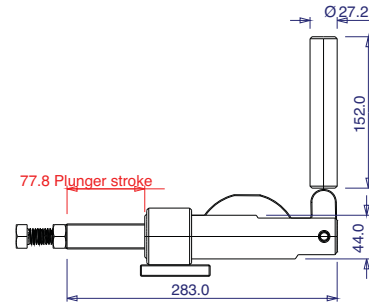
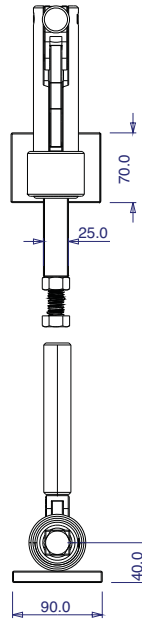

Part No:	GH-30619M
Holding Force:	2273Kg
Plunger Stroke:	77.8mm
Weight:	3.5Kg
Spindle Supplied:	SA-165020

